

**FIREYE EP100S, EP200S, & EP300S
(with selectable operation)
PROGRAMMER MODULES
For use with the FIREYE
FLAME-MONITOR CONTROL**

DESCRIPTION

The Fireye EP100S EP200S, and EP300S programmer modules are used with the FLAME-MONITOR Burner Management Control System (P/N's E110 and E100). Several operational characteristics of these programmers are determined by six (6) dipswitches located on the side of the programmer. These characteristics include the operation of terminals 5 and 6 during PTFI and MTFI (EP100S & EP200S only), extended purge timing, recycle or non-recycle operation (EP300S only), intermittent or interrupted operation of terminal 6 (EP300S only), and the option that requires the 3-P running interlock circuit to be proven open at the start of the operating cycle. Refer to "DIPSWITCHES FOR SELECTABLE OPERATION" for a detailed description of the dipswitches for each programmer. These dipswitches allow the programmer module to be configured to operate as a number of other programmers (eg: EP100S as an EP160, EP200S as an EP270, EP300S as an EP390, etc). Refer to CONFIGURING THE PROGRAMMER MODULES for a detailed description of the various modules associated with each programmer.

The EP100S, EP200S, and EP300S programmers provides start-up programming, safe-start check, and flame monitoring supervision. They insure open damper (high purge) prepurge (EP100S only), proof of low fire position, and fuel valve end switch safety checks. A running interlock circuit on the FLAME-MONITOR system constantly monitors the limit switches, air flow switches, and fuel pressure switches through the programmer. The control is designed to initiate a safety lockout (EP100S) or recycle (EP200S & EP300S) if any of these circuits are open at the improper point in the control cycle. A modulator (firing rate motor) circuit is not provided on the EP300S programmer module. Note: The EP300S has selectable recycle/non-recycle operation of the running interlock circuit via dipswitch #1.

The programmer module will de-energize all fuel valve circuits within four (4) seconds (max.) following a flame failure (two seconds when the EP100S or EP200S is configured as an EP165 or EP265 respectively) or at the end of the pilot trial for ignition period if no flame is detected. An alarm circuit will be energized following a safety lockout.

The programmers include an RJ45 style connector to interface with an integral or remote alpha-numeric display (P/N ED510). The programmers are also backward compatible with the older style ED500 display. The programmers includes two (2) RJ style connectors to connect to an E500 communication interface to reduce transient electrical noise interference. The programmers will also communicate with the E500 via the standard ED550 cables.

The programmer is the heart of the FLAME-MONITOR System and incorporates a plug-in design for ease of installation. It is micro-processor based and stores the burner cycle and on-time history that is accessible with the alpha-numeric display or E500 Communication Interface. If replaced, the new programmer card will begin accumulating a new history.

Refer to Bulletin E-1101 for detailed information on the FLAME-MONITOR System.

INSTALLATION

Remove power from its wiring base before proceeding. Remove control from the wiring base before proceeding.

The EP programmer modules are used with the Fireye EB700 base chassis. They are installed in the chassis by inserting the EP programmer module into the second slot on the control. This slot is marked "Programmer Module" on the side of the chassis.

The EP100S, EP200S, and EP300S programmers are designed to fit only in the proper slot. It cannot be snapped into place if inserted in the wrong location. **DO NOT FORCE THEM.**

The EP100S, EP200S, and EP300S programmers are compatible with both the ED500 and ED510 display modules. See "PROGRAMMER AND DISPLAY MODULE COMPATIBILITY".

An amplifier module and flame scanner are also required for the FLAME-MONITOR control.

ORDERING INFORMATION

P/N	DESCRIPTION
EP100S	Programmer module with selectable operation. Used to replace EP160, EP161 (Extended MTFI), EP170 (Early Spark Termination), and EP165 (Pilot Stabilization) programmer modules.
EP200S	Programmer module with selectable operation. Used to replace EP260, EP261 (Extended MTFI), EP270 (Early Spark Termination), and EP265 (Pilot Stabilization) programmer modules.
EP300S	Programmer module with selectable operation. Used to replace EP380, EP381 (Extended MTFI), EP382 (Early Spark Termination), and EP390 (Pilot Stabilization) programmer modules.

IMPORTANT NOTICE - ACTIVATING THE PROGRAMMER:

The functions of the programmer modules can be modified by changing the positions of the dipswitches. **The dipswitches of the EP100S, EP200S, and EP300S are set at the factory to operate as an EP160, EP260, and EP380 respectively.** If the programmer needs to be modified to another model, make the appropriate dipswitch modifications **before inserting inserting the programmer** into the FLAME-MONITOR chassis. Refer to the sections "DIPSWITCHES FOR SELECTABLE OPERATION" and "FOUR HOUR BURN-IN PERIOD" to modify the function of the programmer modules.

When the EP100S, EP200S or EP300S programmers are initially powered, the ED510 will display:

**PRESS RESET
TO ACCEPT EP**

Press the Reset button to activate the programmer module and, after a 15 second warm-up period, will operate according to the dipswitch settings. There is a four hour time period after the programmer has been activated to still modify the dipswitch settings and change the function of the programmer. After four hours, the function of the programmer cannot be modified. Refer to "FOUR HOUR BURN-IN PERIOD"

CONFIGURING THE PROGRAMMER MODULES

When used with the EB700 Chassis, the EP100S, EP200S, and EP300S programmer modules can be configured to operate and replace a number of programmers (eg: EP100S as an Ep160, EP200S as an EP270, EP300S as an EP390, etc). Refer to Table 1 for the proper dipswitch settings to configure the EP100S, EP200S, and EP300S to operate as the indicated programmer and its related operation and timings.

Note: The EP100S, EP200S, and EP300S programmers will not operate until the programmer is activated via the Reset button. Refer to the section "ACTIVATING THE PROGRAMMER".

TABLE 1

Use	To Replace	Dipswitch Settings						Purge ¹	PTFI		MTFI		FFRT ²
		1	2	3	4	5	6		Term 5	Term 6	Term 5	Term 6	
EP100S	EP160	Dn	Dn	Dn	Dn	Dn	Dn	30 sec.	10 sec.	10 sec.	10 sec.	15 sec.	4 sec.
	EP161	Up	Dn	Dn	Dn	Dn	Dn	30 sec.	10 sec.	10 sec.	10 sec.	30 sec.	4 sec.
	EP165	Up	Up	Dn	Dn	Dn	Dn	30 sec.	5 sec.	10 sec.	---	15 sec. ³	2 sec.
	EP170	Dn	Up	Dn	Dn	Dn	Dn	30 sec.	5 sec.	10 sec.	---	10 sec.	4 sec.
EP200S	EP260	Dn	Dn	Dn	Dn	Dn	Dn	30 sec.	10 sec.	10 sec.	10 sec.	15 sec.	4 sec.
	EP261	Up	Dn	Dn	Dn	Dn	Dn	30 sec.	10 sec.	10 sec.	10 sec.	30 sec.	4 sec.
	EP265	Up	Up	Dn	Dn	Dn	Dn	30 sec.	5 sec.	10 sec.	---	15 sec. ³	2 sec.
	EP270	Dn	Up	Dn	Dn	Dn	Dn	30 sec.	5 sec.	10 sec.	---	10 sec.	4 sec.
EP300S	EP380	Dn	Dn	Dn	Dn	Dn	Dn	30 sec.	10 sec. ⁴	10 sec.	10 sec.	Intermit ⁵	4 sec.
	EP381	Dn	Dn	Dn	Up	Up	Dn	15 sec.	10 sec. ⁴	10 sec.	10 sec.	Intermit ⁵	4 sec.
	EP382	Dn	Dn	Dn	Dn	Up	Dn	1 sec.	10 sec. ⁴	10 sec.	10 sec.	Intermit ⁵	4 sec.
	EP390	Dn	Dn	Up	Dn	Dn	Dn	90 sec.	10 sec. ⁴	10 sec.	10 sec.	Intermit ⁵	4 sec.

¹ Purge timings are adjustable. See "Dipswitches - Purge Timing".

² FFRT is the Flame Failure Response Time.

³ During MTFI, terminal 6 is energized for 5 seconds (pilot stabilization) before energizing terminal 7 for 10 seconds (EP100S configured as EP165 and EP200S configured as EP265 only).

⁴ EP300S programmers can use terminal "X" for spark termination. This requires jumpering terminals 5 and 10 on the wiring base. PTFI timing is 5 seconds on terminal "X".

⁵ EP300S programmers have selectable intermittent or interrupted (15 sec. MTFI) operation of terminal 6 via dipswitch #2.

Note: The EP100S (and all dipswitch configurations) has a non-recycle running interlock circuit (3/P).

The EP200S (and all dipswitch configurations) has a recycle running interlock circuit (3/P).

The EP300S has a selectable (recycle/non-recycle) running interlock circuit (3/P).

CAUTION: When setting dipswitches to select purge and ignition timings, ensure the selections are correct for your application. The dipswitch settings become permanent after the control has been powered four (4) hours (120 VAC applied to L1 and L2) or the settings have been accepted using ED510 keypad/dipsley (See "Bypassing the Four Hour Burn-In Period").

**TIMING CHARTS:
EP100S and EP200S PROGRAMMERS:**

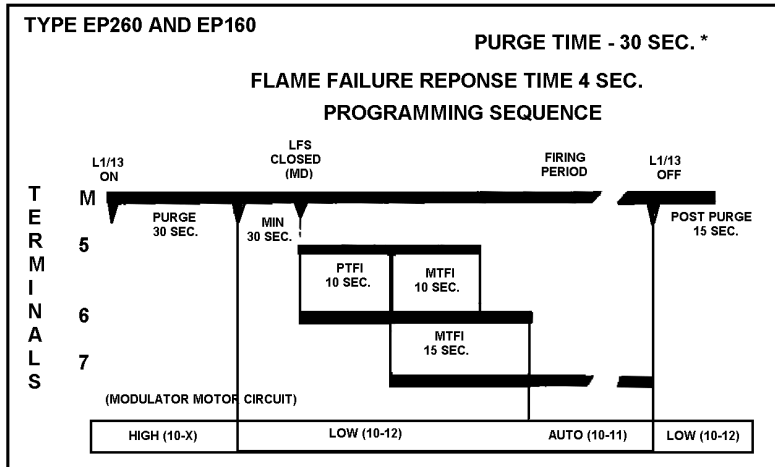

DIPSWITCH SETTINGS

1	2	3	4	5	6
DOWN	DOWN	DOWN	DOWN	DOWN	DOWN

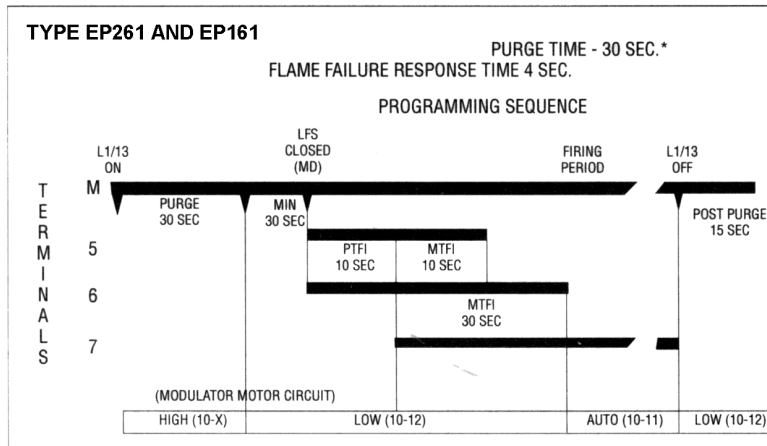

DIPSWITCH SETTINGS

1	2	3	4	5	6
UP	DOWN	DOWN	DOWN	DOWN	DOWN

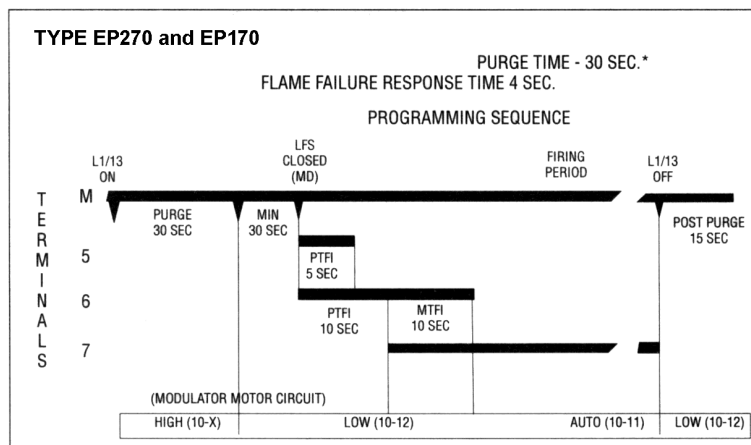

DIPSWITCH SETTINGS

1	2	3	4	5	6
DOWN	UP	DOWN	DOWN	DOWN	DOWN

Purge Timmings are adjustable.
EP100S Programmers have a non-recycle running interlock circuit (3-P).
EP200S Programmers have a recycle running interlock circuit (3-P).

TIMING CHARTS:

EP100S and EP200S PROGRAMMERS:

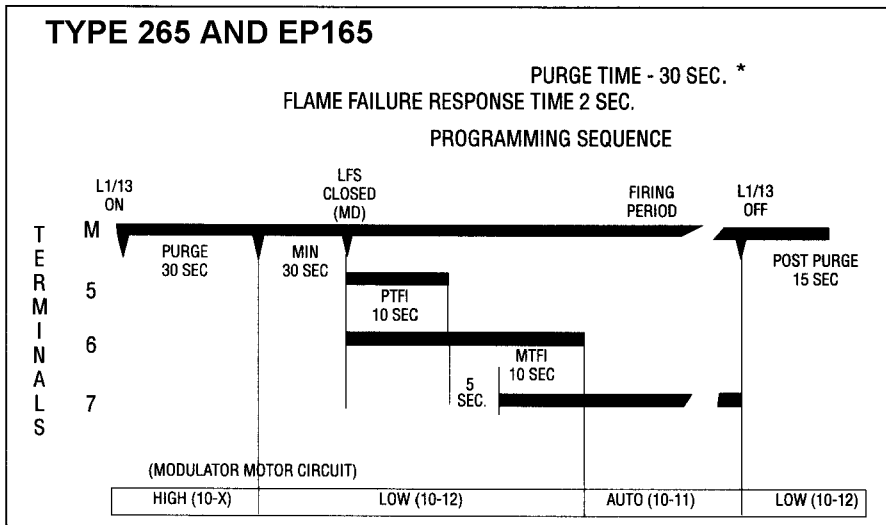

DIPSWITCH SETTINGS

1	2	3	4	5	6
INACTIVE		Down	Down	Down	Down

* Purge timings are adjustable

EP100S Programmers have a non-recycle running interlock circuit (3-P).

EP200S Programmers have a recycle running interlock circuit (3-P).

EP300S PROGRAMMER:

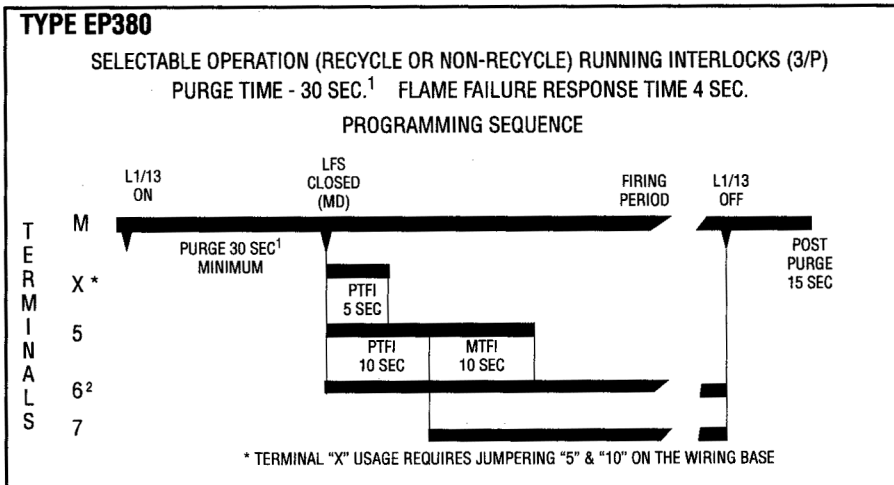

DIPSWITCH SETTINGS

1	2	3	4	5	6
Down	Down	Down	Down	Down	Down

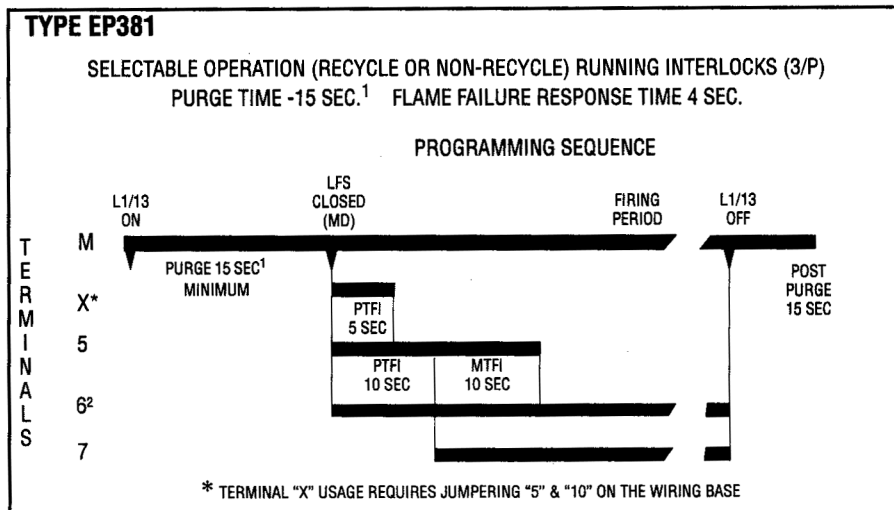

DIPSWITCH SETTINGS

1	2	3	4	5	6
Down	Down	Down	UP	UP	Down

Purge Timings are adjustable.

When dipswitch #2 on the EP300S programmer selects terminal 6 for interrupted operation, terminal 6 is energized for 10 seconds during PTFI and 15 seconds for MTFI.

**TIMING CHARTS:
EP300S PROGRAMMER:**

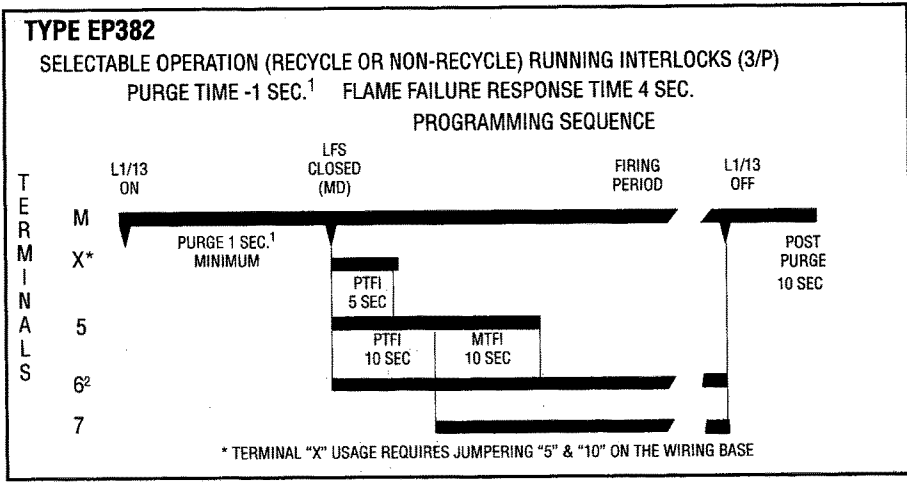

DIPSWITCH SETTINGS

1	2	3	4	5	6
Down	Down	Down	Down	UP	Down

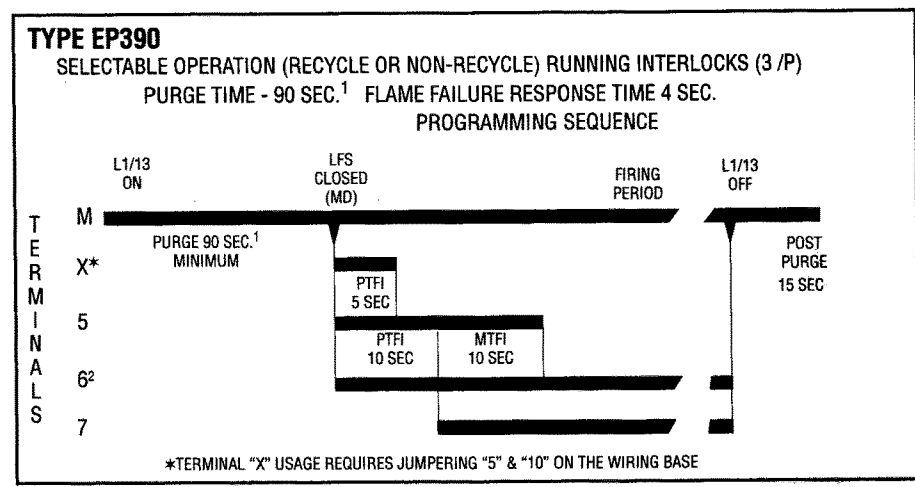

DIPSWITCH SETTINGS

1	2	3	4	5	6
Down	Down	UP	Down	Down	Down

Purge timings are adjustable.

When dipswitch #2 on the EP300S programmer selects terminal 6 for interrupted operation, terminal 6 is energized for 10 seconds during PTFI and 15 seconds for MTFI.

DIPSWITCHES FOR SELECTABLE OPERATION:

Several operational characteristics of the EP100S, EP200S, and EP300S programmer modules are determined by six (6) dipswitches located on the side of the programmer. These characteristics include operation of terminals 5 & 6 during PTFI and MTFI (EP100S and EP200S only), purge timing, recycle or non-recycle operation (EP300S only), intermittent or interrupted operation of terminal 6 (EP300S only), prove the operation of the high fire and low fire interlocks (EP100S only), and the option that requires the 3-P running interlock circuit to be proven open at the start of the operating cycle. These dipswitches allow the programmer module to be configured to operate as a number of other programmers (eg: EP100S as an EP160, EP200S as an EP270, EP300S as an EP390, etc). Refer to CONFIGURING THE PROGRAMMER MODULES for a detailed description of the various modules associated with each programmer.

CAUTION: The various programmer modules (EP160, EP260, and EP380) are interchangeable because they plug into a common chassis. Changing the dipswitches modifies the operation of each programmer module. Care should be taken to insure the proper dipswitch settings. The inappropriate selection or application of a programmer module could result in an unsafe condition hazardous to life and property. Selection and setting of the programmer module and dipswitch settings for a particular application should be made by a competent professional, such as a Boiler/Burner technician licensed by a state or other government agency.

FRONT COVER

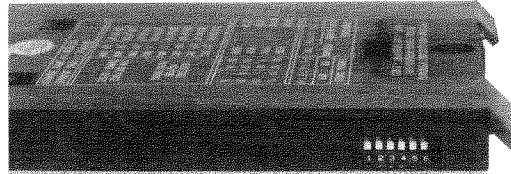

UP

PRINTER CIRCUIT BOARD

DOWN

EP100S and EP200S PROGRAMMER MODULES:

DIPSWITCHES 1 & 2 - OPERATION OF TERMINALS 5 & 6 DURING PTFI AND MTFI:

The main functional difference between the EP160, EP161, EP170, and EP165 programmer modules (as well as the EP260, EP261, EP270, and EP265) is the timings of terminals 5 & 6 during Pilot Trial For Ignition (PTFI) and Main Trial For Ignition (MTFI). The position of dipswitches 1 and 2 allow the user to configure the EP100S and EP200S programmer to operate as any of these programmer modules. See Table 2 to select the various timings.

The EP100S and EP200S is shipped with dipswitches 1 & 2 in the Down position (configured as an EP160 and EP260 respectively).

NOTE: The EP165 and EP265 have a 2 second FFRT time. The EP165 will lockout in the event of a power interruption.

DIPSWITCHES 3, 4, & 5 - PURGE TIMING:

Dipswitches 3, 4, & 5 determine the purge timing for the programmer module. Purge timings are selectable from 30 seconds to 30 minutes. On the EP100S programmer, the purge timing is not initiated until the firing rate motor is driven to the high fire position (10-X made) and the high fire switch is proven closed (term D-8). On the EP200S programmer, the purge timing is initiated as soon as the firing rate motor is commanded to drive to the high fire position (10-X made). At the end of the purge timing, the firing rate motor is driven to the low fire position (10-12), and the control waits and additional 30 second (minimum) until the low fire start interlock is proven closed (M-D). See Table 2 to select the various purge timing.

The EP100S and EP200S are shipped with dipswitches 3, 4 & 5 in the Down position (30 second purge).

DIPSWITCH 6:

- **3-P RUNNING INTERLOCK CIRCUIT PROVEN OPEN TO START (EP100S and EP200S)**
- **VERIFY OPERATION OF HIGH AND LOW FIRE INTERLOCK SWITCHES (EP100S only):**

Dipswitch 6 provides the option that requires the 3-P running interlock circuit to be proven open at the start of the operating cycle. If this option is enabled (switch 6 is Up), the 3-P running interlock circuit is **required to be open** at the start of the operating cycle (L1- 13 circuit closed). If this option is enabled and the 3-P circuit is closed at the start of the operating cycle, the control will hold for one (1) minute waiting for the 3-P circuit to open. If after one (1) minute, the 3-P circuit does not open, the control will lockout.

Also, **on the EP100S programmer only**, when dipswitch 6 is placed in the Up position, the EP100S programmer will require the following actions to occur **or the control will lockout**:

- The 3-P running interlock circuit must be proven open at the start of the operating cycle and then close within 10 seconds.
- The high fire purge interlock circuit (D-8) must be proven open at the start of purge before the FLAME-MONITOR will drive the firing rate motor to high fire (10-X).
- The low fire start interlock circuit (M-D) must be proven open at the end of high fire purge before the FLAME-MONITOR will drive the firing rate motor to the low fire position (10-12).

The EP100S and EP200S are shipped with dipswitch #6 in the Down position (Prove 3-P Open Disabled).

EP300S PROGRAMMER MODULE

DIPSWITCH 1 - RECYCLE OR NON-RECYCLE OPERATION:

Dipswitch 1 determines if the EP300S Programmer will recycle (dipswitch 1 is Down) or lockout (dipswitch 1 is Up) when the running interlock circuit (3-P) is opened during the firing cycle. The programmer is shipped with dipswitch 1 in the "Down" position (recycle operation). See Table 3 for an overview of all of the dipswitch settings.

DIPSWITCHES 2 - INTERMITTENT OR INTERRUPTED OPERATION OF TERMINAL 6:

Dipswitch 2 selects either intermittent or interrupted operation of terminal 6. When terminal 6 is selected for intermittent operation (dipswitch 2 in the "Down" position), terminal 6 remains energized throughout the firing period. When terminal 6 is selected for interrupted operation (dipswitch 2 in the "Up" position), terminal 6 is energized for 10 seconds during PTFI and 15 seconds during MTFI before de-energizing. The programmer is shipped with dipswitch 2 in the "Down" position (Intermittent operation).

DIPSWITCHES 3, 4, & 5 - PURGE TIMING:

The length of the purge timing period is the main difference between the EP380 (30 seconds), EP381 (15 seconds), EP382 (1 second), and the EP390 (90 seconds). Dipswitches 3, 4, & 5 determine the purge timing for the programmer module. Purge timings are selectable from 1 second to 10 minutes. On the EP300S programmer, the purge timing is initiated after the burner/blower motor is energized. See Table 3 for an overview of all of the dipswitch settings.

DIPSWITCH 6 - 3-P RUNNING INTERLOCK CIRCUIT PROVEN OPEN TO START:

Dipswitch 6 provides the option that requires the 3-P running interlock circuit to be proven open at the start of the operating cycle. If this option is enabled (switch 6 is Up), the 3-P running interlock circuit is **required to be open** at the start of the operating cycle (L1-13 circuit closed). If this option is enabled and the 3-P circuit is closed at the start of the operating cycle, the control will hold for one (1) minute waiting for the 3-P circuit to open. If after one (1) minute, the 3-P circuit does not open, the control will lockout. The EP300S programmer is shipped with this option disabled (switch 6 is Down). See Table 3 for an overview of all of the dipswitch settings.

FOUR HOUR BURN-IN PERIOD

The set of six (6) dipswitches located on the side of the EP100S programmer allows the user to modify various functions associated with the operation of the programmer (eg: purge timing, prove 3-P circuit open to start, etc). Refer to the section "DIPSWITCHES FOR SELECTABLE OPERATION" for a detailed explanation of these programmable functions. **THESE FUNCTIONS WILL BECOME PERMANENT AFTER THE CONTROL HAS BEEN POWERED FOR FOUR (4) HOURS.** After this four hour burn-in period, changing the position of the dipswitches will not change the operation of the programmer.

THE USER CAN BYPASS THE FOUR HOUR BURN-IN PERIOD via the ED510 display module. Use the SCROLL and MODE key to select the "Programmer Set-Up" Sub-Menu (Refer to bulletin ED5101) and then the SCROLL key to display the prompt:

**PRESS RESET TO
ACCEPT SETTINGS**

Press the Reset key at this prompt to accept the settings of the dipswitches.

After the above key sequence is completed, changing the position of the dipswitches will not change the operation of the programmer.

TABLE 2

EP100S and EP200S PROGRAMMERS

DIPSWITCH POSITION U=UP, Dn=DOWN						FUNCTIONS			
1	2	3	4	5	6	PTFI		MTFI	
						5	6	5	6
Dn	Dn					10	10	10	15
Dn	Up					5	10	--	10
Up	Dn					10	10	10	30
Up	Up					10	10	--	10 ³
			Dn	Dn	Dn				
			Dn	Dn	Up				
			Dn	Up	Dn				
			Dn	Up	Up				
			Up	Dn	Dn				
			Up	Dn	Up				
			Up	Up	Dn				
			Up	Up	Up				
					Dn		PROVE 3-P OPEN	DISABLED	
					Up		PROVE 3-P OPEN	ENABLED	

¹ Models configured from the EP100S.

² Models configured from the EP200S

³ During MTFI, terminal 6 is energized for 5 seconds (pilot stabilization) before energizing terminal 7 for 10 seconds (EP165 and EP265 only).

Note: EP100S has a non-recycle running interlock circuit (3-P).

EP200S has a recycle running interlock circuit (3-P).

Purge timing on the EP100S does not begin until the high fire switch (D-8 circuit) is proven closed.

TABLE 3

EP300S PROGRAMMER

DIPSWITCH POSITION U=UP, Dn=DOWN						FUNCTION
1	2	3	4	5	6	
Dn						RECYCLE ON 3-P OPEN NON-RECYCLE ON 3-P OPEN
	Up					INTERMITTENT TERM 6 INTERRUPTED
		Dn	Dn	Dn		30 Sec - EP380
		Dn	Dn	Up		1 Sec - EP382 SELECTABLE
		Dn	Up	Dn		5 Sec HIGH FIRE
		Dn	Up	Up		15 Sec - EP381 PURGE TIMING
		Up	Dn	Dn		90 Sec - EP390
		Up	Dn	Up		2 Min LOW FIRE PURGE
		Up	Up	Dn		5 Min TIMING = 30 SEC (MIN)
		Up	Up	Up		10 Min
					Dn	PROVE 3-P OPEN DISABLED
					Up	PROVE 3-P OPEN ENABLED

PROGRAMMER AND DISPLAY MODULE COMPATIBILITY

Two display modules are available for the FLAME-MONITOR control system (P/N's ED500 and ED510). The ED500 is an 8 character LED display. The ED510 is a 2 line by 16 character LCD with keypad to provide both current and historical information pertaining to the operation of the control. Refer to Bulletin ED5101 for a complete description of the features and capabilities of the ED510 display module. The EP100S, EP200S, and EP300S programmers are compatible with both the ED510 and ED500 display module.

RJ STYLE CONNECTORS

The programmer modules include an RJ45 style connector to connect to an alpha-numeric display (P/N ED510). The Ed510 can snap onto the front cover of the programmer module or be mounted remotely. (See Bulletin E-8101 - Remote Mounting Kit). The ED580 cable (provided with the ED510 Display) then plugs into the RJ45 style connectors on both the ED510 display and programmer module.

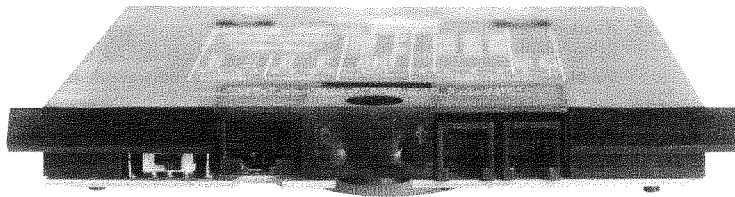

CHECK-RUN SWITCH

RJ45 STYLE CONNECTOR
TO ED510 DISPLAY

RJ12 STYLE CONNECTORS
TO E500 COMMUNICATION INTERFACE

CHECK-RUN SWITCH

The Check-Run switch is located on the top of the EP Programmer Module and can be used to stop the control in its firing sequence at any time except MTFI. IF moved during the MTFI period, it is not functional and automatic programming continues. It is designed to aid in the set-up and adjustment of the burner linkages, pilot assembly, etc.

Refer to bulletin E-1101 for a complete description of the Check-Run switch.

E500 COMMUNICATION INTERFACE

Programmer modules include two (2) RJ12 style connectors to connect to the RS485 Interface on the E500 Communication Interface in a multi-drop wiring configuration with other devices. Refer to Bulletin E5101. Up to six (6) EP programmers and E340 Boiler Room Controls (12 total) can be wired in a multi-drop configuration (Unit address 00 to 15). When connected in this manner to the E500, a unit address must be set on each programmer module connected to the RS485 interface. (See Unit Address). Programmers can also be connected to the E500 via the older style flat ribbon cables (ED550).

UNIT ADDRESS

There are two methods to program the unit address when the programmer module is connected to the E500 via the RS485 interface:

Method One (ED510 display only)

1. Press the SCRL key until the screen displays PROGRAM SETUP.
2. Press the MODE key and the screen displays PROGRAMMER EP100S (or appropriate model).
3. Press the SCRL key until the screen displays UNIT ADDRESS #00 (or appropriate address).
4. Every time the RESET key is held down for one second and then released will increase the address by one.
5. Maximum address is 15. Then the address will roll over to 00.

Method Two (ED510 or ED500)

1. Make sure the control is not in a lockout condition. If so, press the RESET button.
2. Open the operating control (term. L1-13).
3. Move the "Check-Run" switch to the Check position.
4. The display will indicate Unit Address 00 (or the current address).
5. Every time the RESET key is held down for one second and then released will increase the address by one.
6. Maximum address is 15. Then the address will roll over to 00.

OPERATION

The dipswitch settings on the programmer module determine several functions of the FLAME-MONITOR control. These functions include the operation of terminals 5 and 6 during PTFI and MTFI (EP100S & EP200S only), extended purge timing, recycle or non-recycle operation (EP300S only), intermittent or interrupted operation of terminal 6 (EP300S only), and the option that requires the 3-P running interlock circuit to be proven open at the start of the operating cycle. Refer to "DIPSWITCHES FOR SELECTABLE OPERATION" for a detailed description of the dipswitches for each programmer. These dipswitches allow the programmer module to be configured to operate as a number of other programmers (eg: EP100S as an EP160, EP200S as an EP270, EP300S as an EP390, etc). Refer to CONFIGURING THE PROGRAMMER MODULES for a detailed description of the various modules associated with each programmer. The programmers also provide the operator with a constant status indication as well as diagnostic information. The programmers are compatible with either the ED510 (2 line x 16 character LCD display with keypad for local access to historical information) or ED500 (8 character LED display). For purposes of illustration for this bulletin, we will be looking at the messages associated with the ED510 display module. The ED500 display messages will be similar to those of the ED510. Refer to the suggestions shown in this bulletin before proceeding to power the Fireye E110 FLAME-MONITOR system. Items such as scanner installation, short circuit tests and safety information should be reviewed.

CAUTION: On initial power-up and on restarts following a power failure, the display on the control will not become active for 15 seconds.

Start-Up (Normal Cycle)

Note: For direct spark ignited oil burners, substitute the words Main-oil Valve for Pilot Valve.

1. Constant 120 VAC should be available to the L1-L2 terminals only on the wiring base.
2. The operating control circuits (L1-13) will close, signaling the burner to start its firing sequence.
3. Assuming the fuel valve end switch (13-3) is closed, the burner/blower motor (terminal M) circuit is energized. The running interlock (limit) circuit (3-P) will close (e.g.: all limits, interlocks, etc. are proven).
4. The firing rate motor (Modulator Motor) is driven toward the high purge open damper position (10-X ckt. made). **EP100S and EP200S programmers only.**
5. **On the EP200S and EP300S programmers**, the 30¹ second pre-purge period is initiated. **On the EP100S programmer**, when the firing rate motor reaches its open damper position, the Hi Purge switch closes (D-8) and then the prepurge interval of 30¹ seconds is initiated. The ED510 will display:
PURGE 00:05
HIGH FIRE PURGE
6. If the D-8 circuit does not close, the program will hold in this position for ten minutes waiting for it to close. If it does not, the control will lockout. **EP100S programmers only.**
7. When the prepurge is completed, the firing rate motor is driven toward the low purge damper position (10-12 ckt. made). **EP100S and EP200S programmers only.** The ED510 will display:
PURGE 00:35
LOW FIRE PURGE
8. Following the minimum 30 second delay (to permit the firing rate motor to get to the low fire position), the control will wait for the low fire switch (M-D) to close. When it closes, the trial for ignition sequence will start. If after ten minutes, the M-D circuit is not closed, the control will lockout.

¹ Purge timing is selectable via dipswitches.

9. The trial for ignition period begins with Terminal 5 and 6 (and terminal X on the EP300S programmer) being energized simultaneously. This is known as PTFI (Pilot Trial for Ignition). The ED510 will display:

PTFI 00:02
IGNITION TIMING

10. Five (5) seconds after being energized, terminal X is de-energized. **EP300S programmer only.**
11. Terminals 5 and 6 remain energized during the 10 second trial for ignition period. If no flame is detected after ten seconds, the control will de-energize Terminals 5 and 6 and lockout. When flame is detected during this 10 second period, the ED510 will display:

PTFI 20
FLAME SIGNAL

FLAME SIGNAL	
0-9	NOT ACCEPTABLE
10	MINIMUM ACCEPTABLE
20-80	NORMAL

12. With flame proven at the end of PTFI, the main flame trial for ignition (MTFI) period begins. Terminal 7 is energized. The ED510 will display:

MTFI 35
FLAME SIGNAL

13. Terminal 6 is de-energized after another 5 seconds (**EP100S and EP200S programmers**). Terminal 6 remains energized all during the firing period (**EP300S programmer**).
14. The firing rate motor is now sent to the auto position (10-11 ckt made) (**EP100S and EP200S programmers only**) and is under the command of the proportional controller. The ED510 will display:

AUTO 40
FLAME SIGNAL

Note: Trial-for-ignition timings depend on the settings of dipswitches 1 & 2 of the EP100S and EP200S programmers. Refer to the timing charts on pages 3 & 4.

Normal Shutdown

1. When the operating control circuit (L1-13) opens, the main fuel valve is de-energized.
2. The firing rate motor is driven to the low purge position (10-12 ckt mode) (**EP100S and EP200S programmers only**).
3. Following a 15 second post purge, the burner/blower motor is de-energized.
4. The burner is now off and the ED510 will display

STANDBY
L1-13 OPEN

LOCKOUTS

When a safety shutdown occurs, the control will display a message indicating LOCKOUT and the reason for the lockout. The alarm circuit (Terminal "A") will be energized. The non-volatile memory will remember the status of the control even if a power failure occurs. By depressing the reset button on the display, the control can be reset. The button must be held down for one second and then released. Very little force is required to do this. Do not press hard.

Safety Shutdown - EP100S (See below for additional safety shutdowns)

1. If the running interlock circuit does not close within the 1st ten (10) seconds of pre-purge, the control will lockout and the blower motor will be de-energized. If the interlock circuit opens during a start-up or firing period, all fuel valves will be de-energized and the control will lockout.
2. If the proven high fire circuit (D-8) has not closed after a ten (10) minute "Hold" period at the start of prepurge, the control will lockout.
3. When the EP100S is configured as an EP165, the control will lockout after a power interruption to terminals L1 and L2.

Safety Shutdown - EP200S (See below for additional safety shutdowns)

1. If the running interlock circuit (3-P) does not close after a ten (10) minute "Hold" period during prepurge, the control will lockout and the blower motor will be de-energized. If the running interlock circuit opens during the trial for ignition period or firing period, all fuel valves will be de-energized, the control will initiate a 15 second post purge, **and the control will recycle**. See above for condition of running interlock circuit during prepurge.

Safety Shutdown - EP300S (See below for additional safety shutdowns)

1. If dipswitch #1 is in the "Down" position (recycle operation) and the running interlock circuit (3-P) does not close after a ten (10) minute "Hold" period during prepurge, the control will lockout and the blower motor will be de-energized. If the interlock circuit opens during the trial for ignition period or firing period, all fuel valves will be de-energized, the control will initiate a 15 second post purge, **and the control will recycle**. See above for condition of running interlock circuit during prepurge.
2. If dipswitch #1 is in the "Up" position (non-recycle operation) and the running interlock circuit (3-P) does not close after ten (10) seconds into purge, the control will Hold for ten (10) minutes and then lockout. If the 3-P circuit has closed, and then opens after ten (10) seconds into purge, the control will lockout.

Safety Shutdown - EP100S, EP200S, and EP300S Programmers:

1. If dipswitch #6 is in the "Up" position (3-P prove open to start enabled), and the 3-P circuit is closed at the start of the operating cycle, the control will hold for one (1) minute waiting for the 3-P circuit to open. If, after one (1) minute, the 3-P circuit does not open, the control will lockout.
2. If the low fire start circuit (M-D) has not closed after a ten (10) minute "Hold" period at the end of prepurge (3 minute "Hold" period for the EP300S), the control will lockout.
3. If pilot flame is not detected during the 10 second trial for ignition period, the pilot valve and ignition transformer will be de-energized and the control will lockout on safety.
4. If main flame is not detected at the end of the main flame trial for ignition period, all fuel valves will be de-energized and the control will lockout on safety.
5. If the main flame fails during a firing cycle, all fuel valves will be de-energized within 4 seconds (2 seconds when configured as an EP165 or EP265) after loss of flame signal and the control will lockout on safety.
6. If flame is detected when the operating control (L1-13) is open, the control will wait sixty (60) seconds and then lockout if flame is still present. If the operating control closes and flame is detected during purge, the blower motor (term M) remains energized and the purge sequence is put on hold. If the flame signal goes away within sixty (60) seconds, the control will proceed with a normal start-up. If flame is still present after sixty (60) seconds, the control will lockout.
7. Additional lockout messages and causes are described in the following pages.

NOTE: *Manual Reset is required following any safety shutdown.*

NOTE: Depressing the reset button during a cycle will cause the control to shut the burner down and recycle.

MESSAGES DISPLAYED ON ED510 DISPLAY MODULE

RUN MESSAGES

STANDBY L1-13 OPEN	The operating control of the FLAME-MONITOR (terminals L1-13) is open.
PURGE 00:05 HIGH FIRE PURGE	Firing rate motor sent to high fire (term. 10-X made), purge timing displayed upper right hand corner. EP100S and EP200S programmers only.
PURGE 00:35 LOW FIRE PURGE	Firing rate motor sent to low fire (term. 10-12 made) EP100S and EP200S programmers only. Purge timing displayed in upper right hand corner.
PTFI 00:02 IGNITION TIMING	PTFI timing started. Pilot not proven yet. PTFI timing displayed in upper right hand corner.
PTFI 19 FLAME SIGNAL	Pilot flame proven during PTFI. Flame signal strength displayed in upper right hand corner.
MTFI 25 FLAME SIGNAL	Main flame proven during MTFI. Flame signal strength displayed in upper right hand corner.
AUTO 40 FLAME SIGNAL	Modulator motor sent to auto position (term 10-11 made). EP100S and EP200S programmers only. Flame signal strength displayed in upper right hand corner.
POST PURGE 00:05 CYCLE COMPLETE	Demand satisfied. L1-13 open. Blower motor de-energized 15 seconds after L1-13 opens.

HOLD MESSAGES

HOLD STANDBY
3-P INTLK CLOSED
Dipswitch #6 (3-P Proven Open To Start) is set in the "Up" position (Enabled). AT the start of the cycle, the 3-P circuit was closed. The control will "Hold" in this position for 60 seconds and then lockout if the 3-P circuit does not open.

HOLD PURGE
3-P INTLK OPEN
The running interlock circuit (3-P) has not closed within the first ten (10) seconds of purge, The control will "Hold" this position for ten (10) minutes and then lockout. **EP200S and EP300S programmer only.**

HOLD PURGE 00:11
D-8 LIMIT OPEN
The control has driven the firing rate motor to high purge (term. 10-X made) and is waiting for the hire fire switch (term. D-8) to close. It will "Hold" this position for ten (10) minutes and then lockout if the D-8 circuit does not close. **EP100S programmer only.**

HOLD PURGE 00:11
M-D LIMIT OPEN
The control has finished purge and the Firing rate motor is driving to the low fire position (term. 10-12 made) waiting for the low fire switch (term. M-D) to close. It will "Hold" this position for ten (10) minutes (3 minutes for the EP300S) and then lockout if the M-D circuit does not close.

HOLD 19
FALSE FLAME
Flame has been sensed during the burner off time (term. L1-13 open). This message will hold indefinitely as long as L1-13 remains open. Flame signal strength is displayed in the upper right hand corner. If flame is still sensed when L1-13 closes, this message will be displayed for 60 seconds and then lockout.

LOCKOUT MESSAGES

LOCKOUT STANDBY
3-P INTLK CLOSED
Dipswitch #6 (3-P Proven Open To Start) is set in the Up position (Enabled). At the start of the cycle, the 3-P circuit was closed, and the control waited 60 seconds for the 3-P circuit to open.

LOCKOUT PURGE
D-8 LIMIT OPEN
The control has held for more than 10 minutes waiting for the high fire switch (D-8) to close. **EP100S programmer only.**

LOCKOUT PURGE
3-P INTLK OPEN
The running interlock circuit (3-P) has opened during the purge period or failed to close within the first 10 seconds of purge. **EP100S programmer.**
or
The running interlock circuit has not closed after a ten (10) minute "Hold" period during purge. **EP200S programmer.**
or
Dipswitch #1 (Recycle/Non-recycle) is in the "Down" position (Recycle operation). The running interlock circuit has not closed after a ten (10) minute "Hold" period. **EP300S programmer,**
or
Dipswitch #1 (Recycle/Non-recycle) is in the "Up" position (Non-recycle operation). The running interlock circuit (3-P) has initially closed during purge and then opened during the purge period. **EP300S programmer.**

LOCKOUT PURGE
13-3 FVES OPEN
The fuel valve end switch wired between terminals 13 and 3 opened during purge or at start up.

LOCKOUT PURGE
M-D LIMIT OPEN
The control has held for more than 10 minutes waiting for the low fire switch (M-D) to close.

LOCKOUT PTFI
3-P INTLK OPEN
The running interlock circuit (3-P) has opened during the pilot trial for ignition period. **EP100S programmer or EP300S programmer with Dipswitch #1 in the "Up" position (Non-recycle operation).**

LOCKOUT MTFI 3-P INTLK OPEN	The running interlock circuit (3-P) has opened during the main trial for ignition period. EP100S programmer or EP300S programmer with Dipswitch #1 in the "Up" position (Non-recycle operation).
LOCKOUT AUTO 3-P INTLK OPEN	The running interlock circuit (3-P) has opened during the main burner on period. EP100S or EP300S with Dipswitch #1 in the "Up" position (Non-recycle operation).
LOCKOUT STANDBY FALSE FLAME	A flame has been sensed during the burner off period (L1-13 open) or during the purge period for sixty (60) seconds.
LOCKOUT PTFI FLAME FAIL	A flame failure occurred during the pilot trial for ignition period.
LOCKOUT MTFI FLAME FAIL	A flame failure occurred during the main trial for ignition period.
LOCKOUT AUTO FLAME FAIL	A flame failure occurred during the main burner on period.
LOCKOUT PTFI SCANNER NOISE	This message appears because of ignition cable noise. Reroute scanner wires away from high voltage ignition cables. Check for proper spark gap. Check for proper grounding of wiring base and power supply. Replace worn ignition cable and/or faulty connections.
LOCKOUT PURGE SHORT CIRCUIT TERMINAL 5,6, OR 7	Excessive current or short circuit detected on terminals 5, 6, or 7. The control will lockout upon sensing this condition on two consecutive cycles.
LOCKOUT PTFI FUEL VALVE STATE CHANGE	During pilot trial for ignition period, voltage sensed on terminal 7 is different from the previous cycle. (eg: jumper added or removed between term. 7 and 5 or 6).
LOCKOUT AUTO LINE FREQUENCY NOISE DETECTED	Electrical noise detected on terminals L1 and L2. The time when the noise was detected will appear in the upper right hand corner.
LOCKOUT AC POWER FAIL	A power interruption to terminals L1 and L2 has caused the control to lockout. EP100S programmer configured as an EP165.

CHECK MESSAGES

CHECK PURGE 00:15 D-8 HIGH LIMIT	The "Run-Check" switch has been placed in the Check position during purge and will hold indefinitely. The firing rate motor is being driven to the high purge position.
CHECK PURGE 00:45 M-D LOW LIMIT	The "Run-Check" switch has been placed in the Check position after high fire purge and will hold indefinitely. The firing rate motor is being driven to the low fire position.
CHECK PTFI 19 FLAME SIGNAL	The "Run-Check" switch has been placed in the Check position during the pilot trial for ignition period. Flame signal strength is displayed in the upper right hand position. The control will lockout on safety only when no flame signal is sensed for a continuous 30 seconds while the control is in the Check position.
CHECK AUTO 25 LOW FIRE SIGNAL	The "Run-Check" switch has been placed in the Check position during the main burner on period. and the firing rate motor is driven to the low fire position. Flame signal strength is displayed in the upper right hand corner.

DIAGNOSTIC MESSAGES

	POSSIBLE CAUSE	SOLUTION
LOCKOUT AUTO CHECK AMPLIFIER	<ul style="list-style-type: none">- High electrical noise- Defective field wiring.- Defective amplifier.- Defective IR scanner.	<ul style="list-style-type: none">- Check for proper ground on power supply.- Install noise suppressor on power supply (P/N 60-2333).- Make sure line phase on interlock circuits is the same as found on L1/L2 power supply to E100.- Replace amplifier.- Replace IR cell.
LOCKOUT PTFI CHECK CHASSIS	<ul style="list-style-type: none">- Voltage on terminal 7 at improper time.	<ul style="list-style-type: none">- Check wiring to terminal 7.
LOCKOUT PURGE CHECK PROGRAMMER	<ul style="list-style-type: none">- Voltage on terminals 5 or 6 at improper time.	<ul style="list-style-type: none">- Check wiring to terminals 5 and 6.
LOCKOUT AUTO CHECK SCANNER	<ul style="list-style-type: none">- Flame signal detected during shutter close time on 45UV5 scanner.	<ul style="list-style-type: none">- Stuck scanner shutter. Replace 45UV5 scanner.
LOCKOUT AUTO CHECK EXPANSION MODULE	<ul style="list-style-type: none">- The E300 Expansion Module has a defective optocoupler.	<ul style="list-style-type: none">- Replace E300 Expansion Module
LOCKOUT AUTO AMPLIFIER AUTO CHECK FAIL	<ul style="list-style-type: none">- Amplifier has failed diagnostic checks.	<ul style="list-style-type: none">- Replace amplifier.

TYPICAL WIRING DIAGRAM FOR PILOT IGNITED BURNERS USING EP100S OR EP200S PROGRAMMERS:

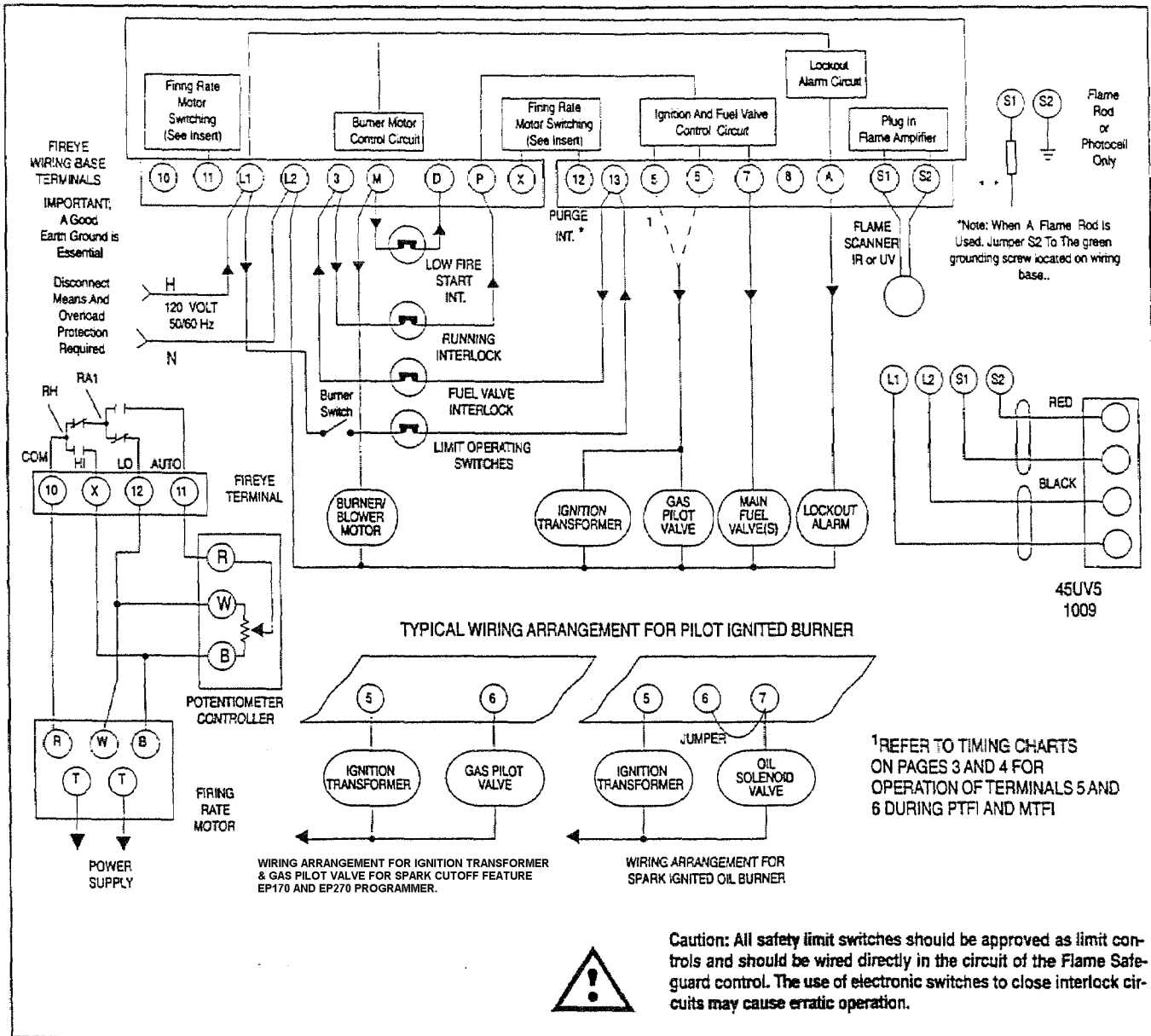

TYPICAL WIRING DIAGRAM FOR PILOT IGNITED BURNERS USING EP300S PROGRAMMER:

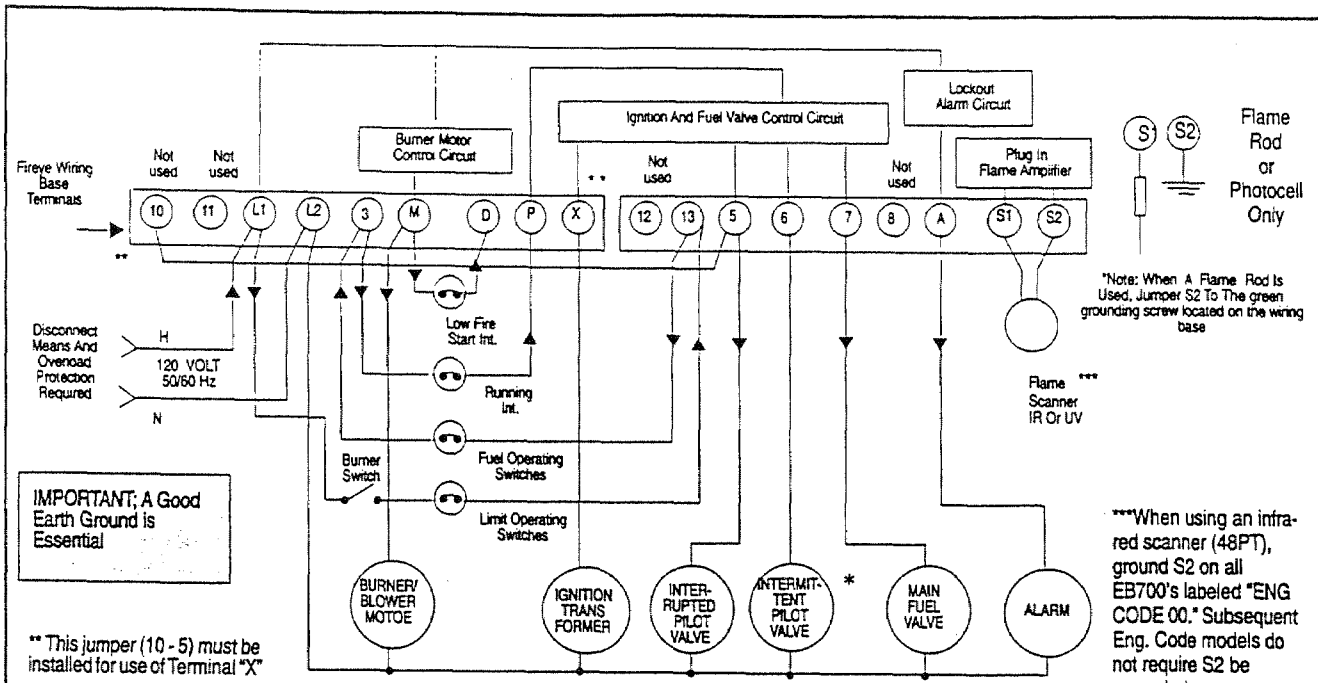

*INTERMITTENT PILOT NOT PERMITTED ON OIL BURNERS
SELECTABLE OPERATION (INTERMITTENT OR INTERRUPTED) ON TERMINAL 6.

Part Number	Trial for Ignition/ Pilot (Seconds)	Trial for Ignition/ Main (Seconds)
		Term X
	Term 5 & 6	Term 6
EP300S	5	10
	10	Intermittent ¹
	10	15 ²

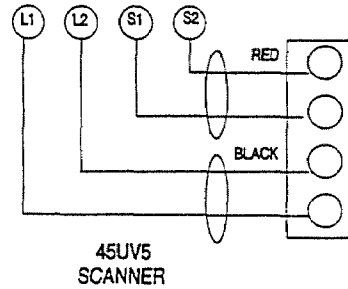
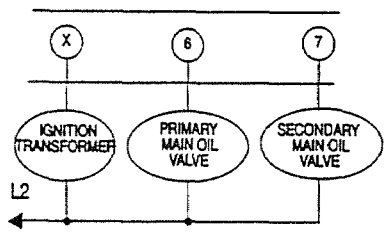

¹ Dipswitch 2 set for intermittent operation.
² Dipswitch 2 set for interrupted operation.

Caution: All safety limit switches should be approved as limit controls and should be wired directly in the circuit of the Flame Safeguard control. The use of electronic switches to close interlock circuits may cause erratic operation.